

EMONA ETT-101/C

New Generation Multi-Experiment Digital & Analog Telecoms Experimenter

The most cost effective experimenter
to help you teach Signals & Systems and
Modern Communications Systems Theory



Easily expandable
with a suite of
specialist expansion
boards

EMONA INSTRUMENTS
www.ett101.com

Flexible and expandable experimenting

Extensive Experiment Coverage

BASIC EXPERIMENTS

Fundamental Signals Experiments
Analog Modulation
Digital Modulation

ADVANCED EXPERIMENTS

Eye Diagrams and Noisy Channels
Signal Constellations

NEW Digital Modulations Schemes with Bit Error Rate (BER) Signal-to-Noise (SNR)
Eye Diagrams and ISI
Line Codes and Bit Clock Regeneration

NEW SDR EXPERIMENTS (Software Defined Radio)

Educational GNU Radio Experiments

LATEST SIGNALS & SYSTEMS HANDS-ON HARDWARE EXPERIMENTS

Comprehensive 15 lab experiments covering continuous and discrete time structures, from sampling, complex numbers, convolution, Laplace, z-transforms through to filter design & implementation

FIBER OPTICS EXPERIMENTS

TX and RX of Optics Signals
Fiber Optic Couplers and WDM
Physics of Fibers Experiments



Two models available -

Emona ETT-101 "BiSKIT" Standard Experimenter

Emona ETT-101C "BiSKIT" with Digital Instruments In-built

ETT-101 standard EXPERIMENTER

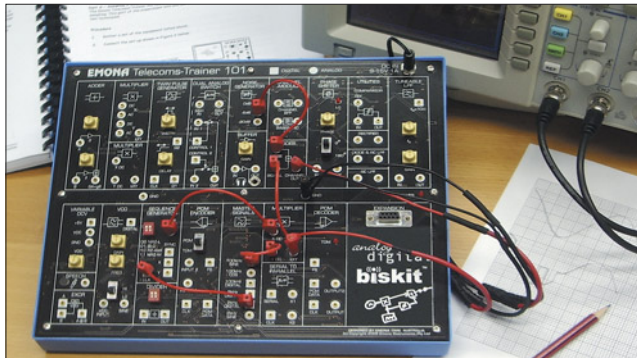

Completely self contained within a single, low-profile case, the ETT-101 requires only a standard 12V DC plug-pack. Provides a comprehensive suite of independent functional blocks to build a wide variety of experiments. With expansion socket for a range of add-on boards.

Waveforms can be displayed on whatever equipment is available to the student, such as: a low cost lab oscilloscope, or a PC-based virtual instrument.

ETT-101C all-in-one with DIGITAL INSTRUMENTS

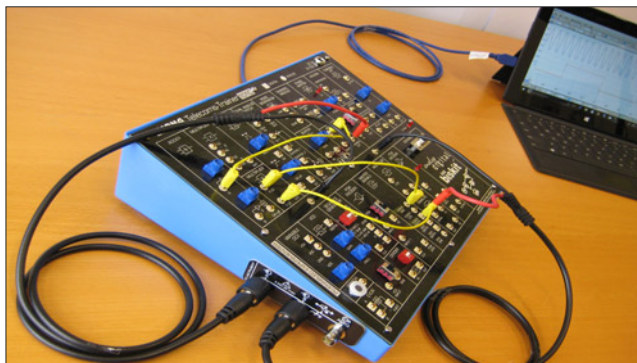

Includes all the experiment and expansion capabilities of the ETT-101 STANDARD EXPERIMENTER, plus an in-built PC-based multi-instrument, providing:

- OSCILLOSCOPE - 2 Channel, 100MS/s, full featured
- SPECTRUM DISPLAY - 2 Channel, 10MHz bandwidth
- FUNCTION GENERATOR with Arbitrary Waveform Generator

USB interface to PC, running the powerful PicoScope instrument display software.

Students apply theory to build experiments

ETT-101/C implements the BLOCK DIAGRAM approach to explore telecoms theory

$$A(1 + m \cdot \cos \mu t) \cdot B \cos \omega t = AM$$

1. Telecoms theory is expressed as Math

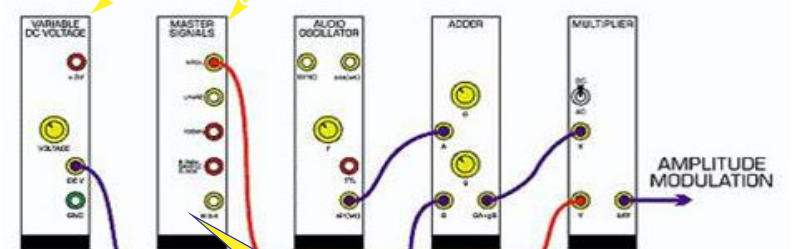
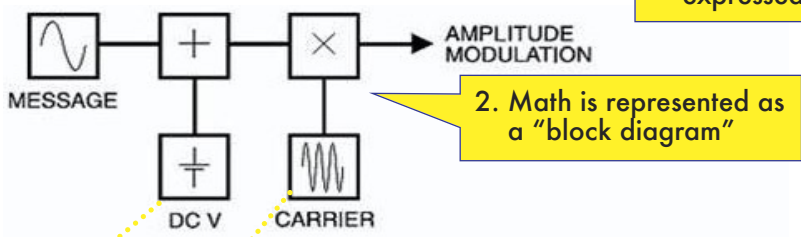

4. Students patch together the ETT-101 modules to build experiments

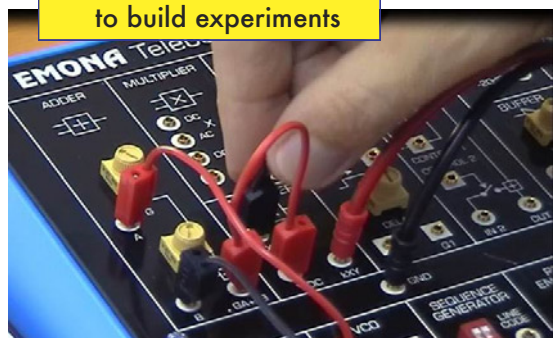

90+ different experiments can be implemented with the ETT-101/C

Replacing 10 or more "single panel" trainers
Designed for Students to Learn and Explore

Learning-by-doing - Hands-on-practical experiences for students

Following are examples of how students implement theoretical block diagrams to build each experiment by patching together functional circuit blocks.

SAMPLING and RECONSTRUCTION

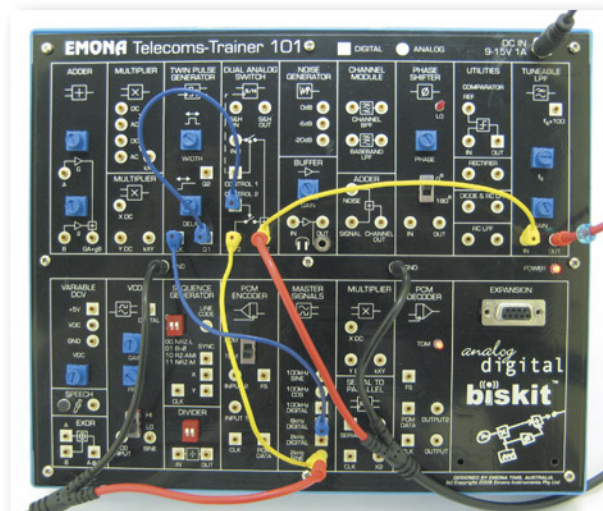

Patching a sampling & reconstruction experiment uses 4 of the ETT-101's functional blocks: MASTER SIGNALS, TWIN PULSE GENERATOR, DUAL ANALOG SWITCH and TUNEABLE LFP

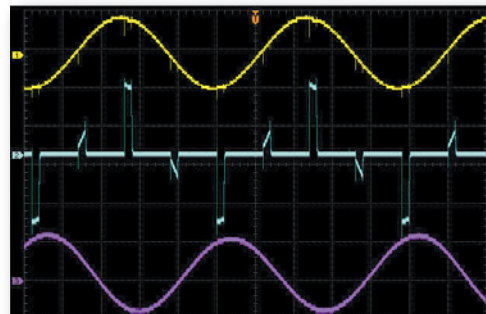

Actual sampling & reconstruction waveforms.

PCM ENCODING and PCM DECODING



Patching a PCM encoding & decoding experiment uses 3 of the ETT-101's functional blocks: MASTER SIGNALS, PCM ENCODER and PCM DECODER.

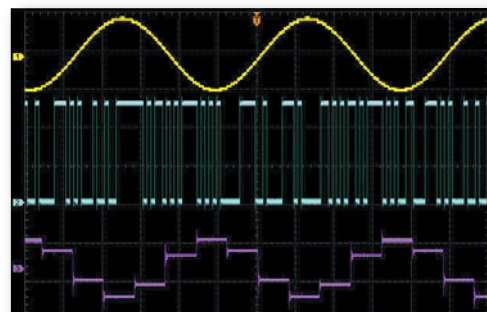

Actual PCM encoding & decoding waveforms.



LINE-CODE ENCODING, DECODING and EYE DIAGRAMS



Patching a line-code encoding & decoding experiment with signals passing through a noisy bandlimited channel uses 6 of the ETT-101's functional blocks:

SEQUENCE GENERATOR/LINE-CODE ENCODER, MASTER SIGNALS, NOISE GENERATOR, CHANNEL FILTER, CHANNEL ADDER and LINE-CODE DECODER.

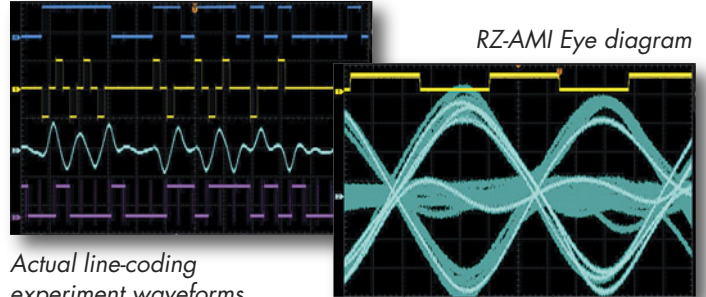

Actual line-coding experiment waveforms.

FSK MODULATION and FSK DEMODULATION

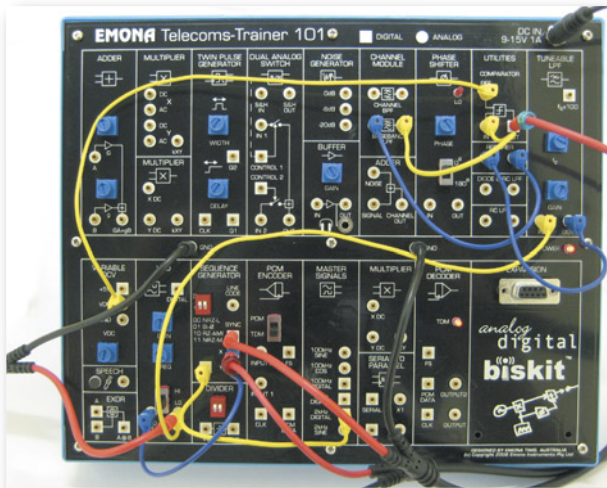

Patching an FSK modulation and demodulation experiment uses 7 of the ETT-101's functional blocks:

VCO, SEQUENCE GENERATOR, MASTER SIGNALS, BANDPASS FILTER, UTILITIES, VARIABLE DC V and TUNEABLE LPF.

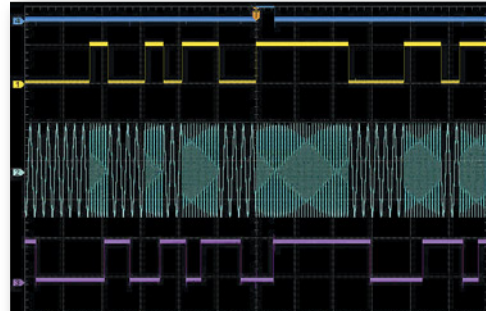

Actual FSK experiment waveforms.

DSSS SPREAD SPECTRUM MODULATION and DEMODULATION

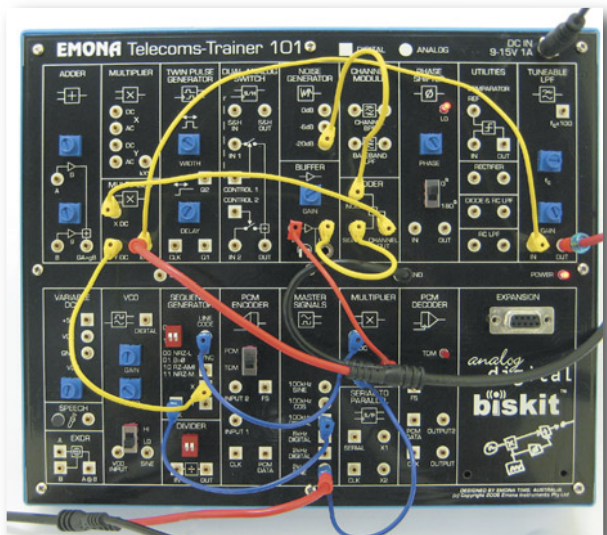

Patching an DSSS modulation and demodulation in a noisy channel experiment uses 8 of the ETT-101's functional blocks: SEQUENCE GENERATOR, MASTER SIGNALS, MULTIPLIER (x2), NOISE GENERATOR, ADDER, CHANNEL GAIN and TUNEABLE LPF.

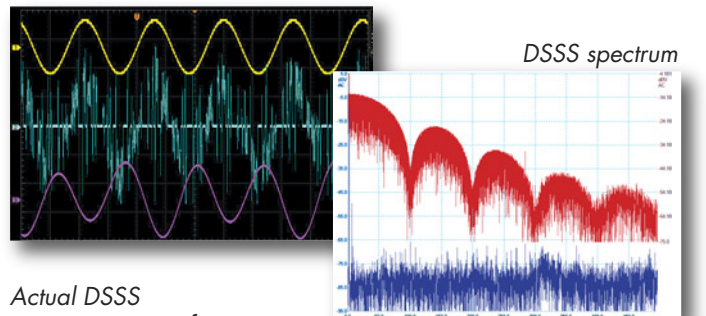

Actual DSSS experiment waveforms.



Add new experiment topics with convenient expansion options

ETT-101/C Optional Expansion Boards

COMPACT MULTI-EXPERIMENTER available in 2 models:

- **ETT-101** base unit, standard experimenter. Use with external oscilloscope
- **ETT-101C** with in-built digital scope, spectrum analyser & function generator

STUDENTS BUILD EXPERIMENTS BY PATCHING TOGETHER FUNCTIONAL BLOCKS

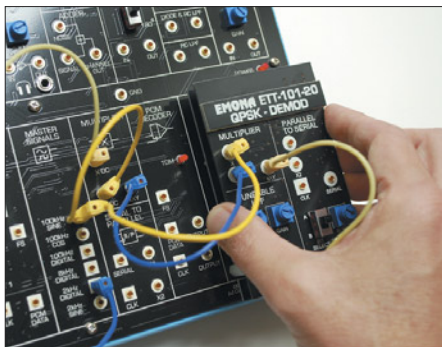
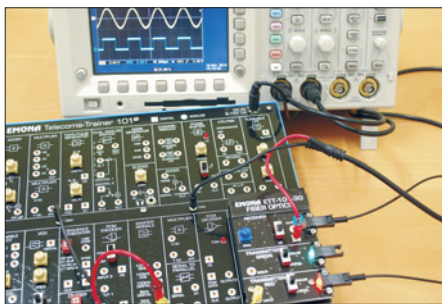

“Students patch together simple building blocks to make real communications systems”

LEARNING-BY-DOING

Using the ETT-101, students learn the fundamental concepts by actually building telecommunications experiments at the block diagram level. Theory comes to life as they build the modulation and coding schemes.

With the ETT-101 students learn by trying “what-if” scenarios (and are free to make mistakes, analyse and self correct) to investigate the telecommunications theory they learn in class. With the ETT-101, your students will learn more, and remember more.

The ETT-101 accessories kit includes: 20 x stackable patch cords, User Manual, Experiments in Modern Analog and Digital Telecommunications Volume-1 and Volume-2, and a 12V plug pack.

FAST and SIMPLE EXPANSION

ETT-101-XX ADD-ON BOARDS simply plug into the ETT-101 EXPANSION slot.

COMPLETE WITH DETAILED LAB MANUALS

Each ETT-101-XX ADD-ON BOARD includes a detailed experiment lab manual.

- Unrivalled with a wide range of over 90 modern communications, SDR, signals & systems and fiber optics experiments in one compact experimenter
- Educationally proven experiment method to help students see the relationship between math and the real world



ETT-101/C Optional Expansion Boards (cont.)

QPSK EXPERIMENT BOARD : ETT-101-20



The ETT-101-20 QPSK Experiment expansion board will allow a complete QPSK modulation / QPSK IQ-branch demodulation experiment to be implemented.

Detailed experiments documented in the ETT-101 Volume 3 Lab Manual include:

- QPSK modulation and IQ-branch demodulation in a noisy channel;
- Signal Constellations.

FIBER OPTICS BOARD : ETT-101-30



The ETT-101-30 FIBER OPTICS Experiment expansion board includes three independent functional blocks, providing an electrical-optical and optical-electrical interface for the ETT-101. When added to the ETT-101 it will allow a complete optical link to be established, for analog or digital signals.

Detailed experiments documented in the ETT-101 Volume 4 Lab Manual include:

- Transmission and reception of analog and digital signals;
- ETT-101 PCM-TDM implementation of a "T1" optical link.

LINE-CODING & PLL BOARD : ETT-101-21



The ETT-101-21 Line-Coding & PLL Experiments expansion board for implementing Line-Code Decoding, DPSK demodulation, and FM PLL demodulation experiments.

Detailed experiments documented in the ETT-101 Volume 3 Lab Manual include:

- Line-Code Decoding and decision making in a noisy baseband channel;
- DPSK in a noisy passband channel;
- FM demodulation using the PLL.

FIBER OPTICS COUPLER & WDM BOARD : ETT-101-31

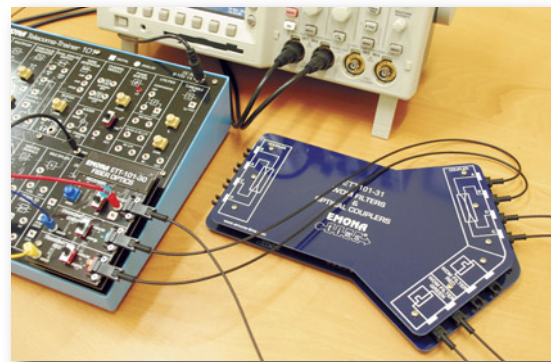

The ETT-101-31 FIBER OPTIC COUPLERS and WDM FILTERS Experiment expansion board includes four independent functional blocks. When added to the ETT-101 and ETT-101-31 it will allow a complete bi-directional and WDM fiber optic links to be implemented.

Detailed experiments documented in the ETT-101 Volume 4 Lab Manual include:

- Optical signal splitting and combining;
- Fiber optic bi-directional communications;
- Wave Division Multiplexing optical link

ELECTRONIC CIRCUITS PROJECT BOARD : ETT-101-10

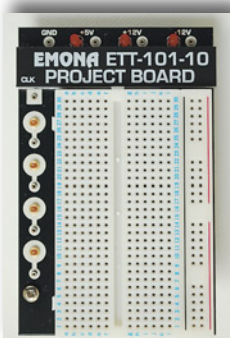

The ETT-101-10 Electronic Circuits Project Experiment board allows students to build their own analog and digital electronic circuits and interface them with the ETT-101 functional blocks. Example circuits include passive and active filters and oscillators.

Includes 14 electronic circuits projects experiment manual.



ETT-101/C Optional Expansion Boards (cont.)

PHYSICS OF FIBERS KIT : ETT-101-32

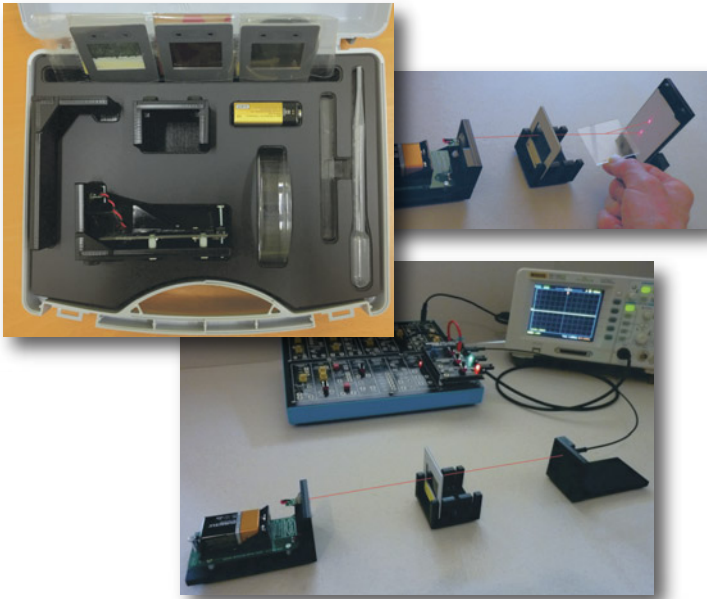

The ETT-101-32 PHYSICS OF FIBERS ACCESSORY KIT is used together with the ETT-101 and the ETT-101-30 FIBER OPTICS expansion board.

Detailed experiments documented in the ETT-101 Volume 4 Lab Manual include:

- Guiding Light Using Total Internal Reflection
- Losses in Fiber Optic Networks
- Polarization
- Bending Losses in Fiber Optic Systems
- Connectors

All Kit components included in a compact carry case: ETT-101-32S laser source; Fiber holder stand; Slide holder; Semicircular Perspex block; Screens; Clear plastic light guide; Clear Perspex slide; Green reflective-absorption slide; Scattering slide; Polarizer slides; Polarizer disc; Quarter-wave plate slide; Stripped optical patch lead; Adapted bulkhead connector; Spacers; Water-drops dispenser

NEW

BER UTILITIES : ETT-101-22

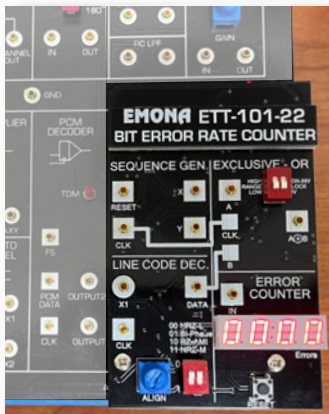

The ETT-101-22 BIT ERROR RATE COUNTER EXPERIMENTS BOARD includes four individual modules for implementing fundamental Bit Error Rate counting instrumentation.

The ETT-101-22 Board allows students to quickly and easily set-up BER instrumentation. The purpose of this add-on board is to dispel the mystery BER measurement, and examine the effect of signal-to-noise ratio (SNR) on BER.

Students are guided, step-by-step, to gain confidence and understanding in the concept of Bit Error Rate measurement by completing the Volume 3 experiment, "Bit error rate measurements in a noisy baseband channel."

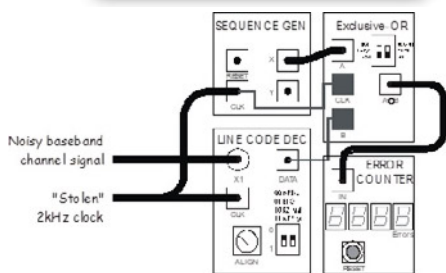

- BER implementation patching diagram

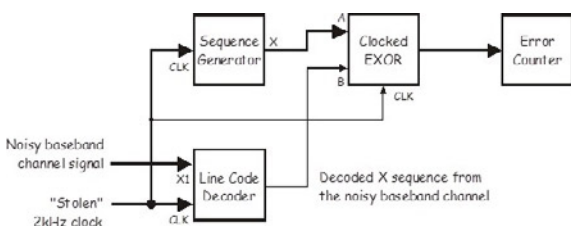

- BER implementation block diagram

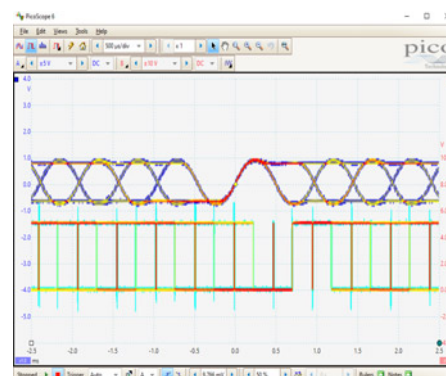

- BER implementation scope display showing user adjustable DECISION POINT viewing the EYE DIAGRAM

ETT-101/C Optional Expansion Boards (cont.)

NEW

SDR UTILITIES BOARD : ETT-101-23

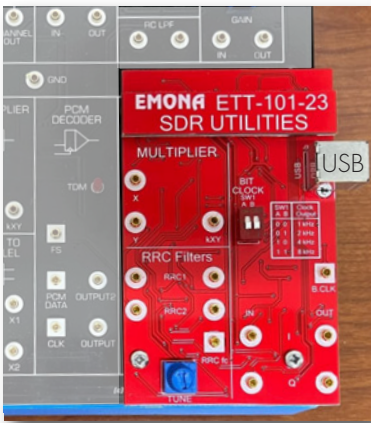

**Plug-and-play.
No Install.
Complete LINUX
with GNURadio.**

The ETT-101-23 SOFTWARE DEFINED RADIO BOARD is supplied as a complete, zero install solution. One step boot-and-run USB thumb drive has pre-installed LINUX with the full GNU Radio.

A simple, practical student introduction to Software Defined Radio, with experiments implemented utilizing the popular, open source GNU Radio SDR software.

Detailed experiments include:

- Familiarization with SDR software and hardware
- TX with SDR and RX with ETT-101 hardware blocks
- Exploring sampling and resampling
- TX with ETT-101 hardware blocks and RX with SDR
- Exploring digital modulation schemes in SDR



SIMPLE EXAMPLE

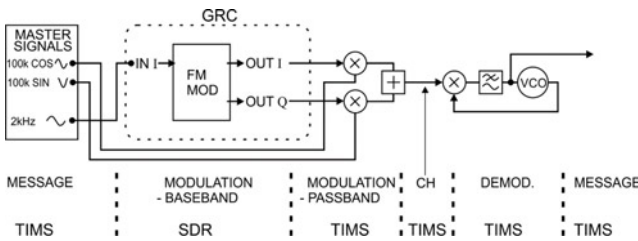

1 - SDR Experiment block diagram

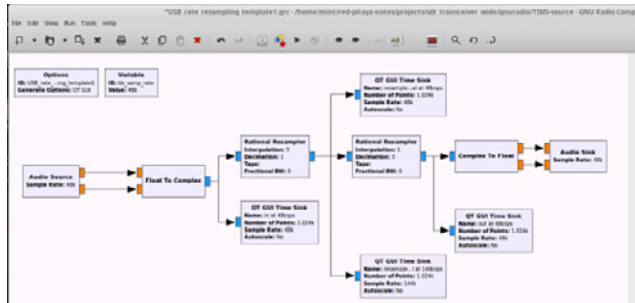

4 - Launching GNURadio

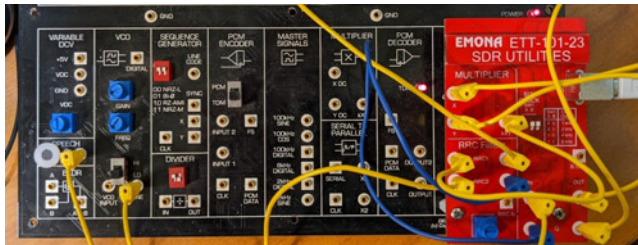

2 - SDR Experiment patching on the hardware

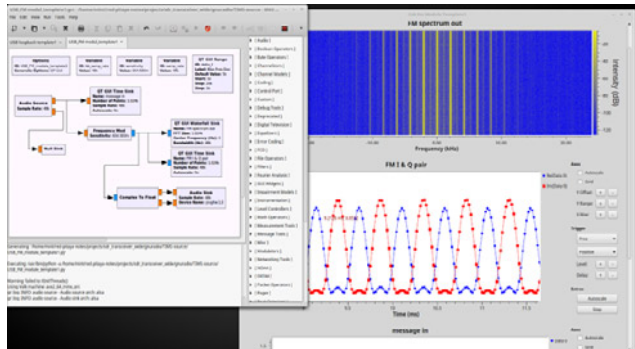

5 - Run/execute GNURadio program

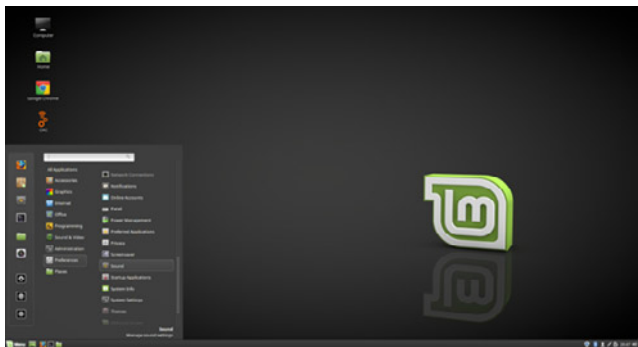

3 - Launching LINUX

COMPLETE, ZERO-INSTALLATION EXPERIENCE !

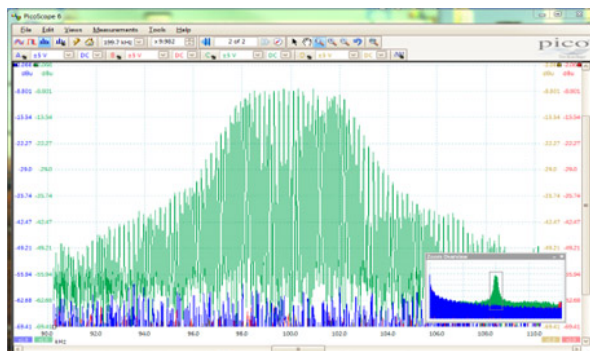

6 - View live, real-time signals and spectra



ETT-101/C Optional Expansion Boards (cont.)

**LATEST
RELEASE**

SIGNALS & SYSTEMS EXPERIMENTS BOARD : ETT-101-40

Students work with

- Convolution
 - Complex Numbers
 - Correlation
 - Laplace & z-Transforms Math
- and more, in the real world**

The Emona ETT-101-40 add-on board enables students to patch together continuous time and discrete-time systems in real hardware for circuit theory, digital signal processing and signals & systems courses.

The Emona ETT-101-40 Signal Systems add-on board for the Emona ETT-101/C Experimenter makes it possible for students to experience at first hand the interaction between the theory and mathematics of the digital signal processing, circuit analysis and signals and systems textbooks, with the real world of hardware and of signals in wires and waves.

The accompanying 15 experiment Lab Manual covers introductory level experiments, designed to provide hands on exercises covering most of the key concepts and challenges in an undergraduate Signal Processing and Signals & Systems courses.

The ETT-101-40 Lab Manual is designed to provide a practical "hands-on", experiential, lab-based component to the theoretical work presented in lectures on the topics typically covered in introductory signals courses for engineering students.

This material is not only for electrical engineers. With an understanding of differential equations, algebra of complex numbers and basic systems theory, engineering students in general can reinforce their understanding of these important foundational principles through practical laboratory course work where they see the "math come alive" in real circuit based signals. This provides a foundation for further study of communications, control, and systems engineering in general.

Students take responsibility for the construction of the experiments and "learning by doing" to consolidate their knowledge of the underpinning theory, which at times is

particularly abstract and hard to grasp for these early engineering students. They are not constrained by the software and need to be systematic in debugging their own systems when results do not meet their expectations.

The common reaction of early students when confronted with "Complex Analysis" is one of confusion and regression to "rote-learning" in order to survive the examination process. This manual has as its predominant aim to create real, "hands-on" implementation of the theory, in such a way that the student can directly articulate and connect the mathematical abstractions with real world implementations. It is a journey of personal discovery where the motto is "why is it so?"

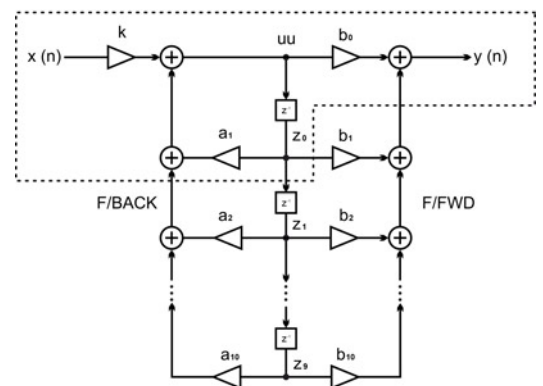
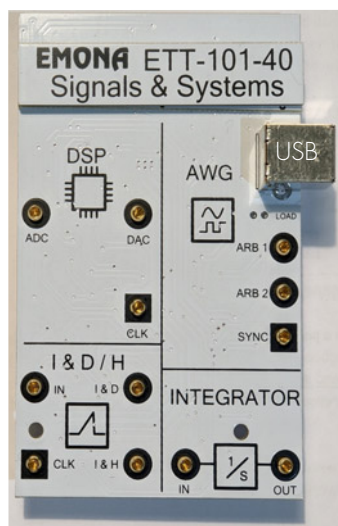

A powerful additional feature: LAB 15 offers the functionality to configure multiple DSP filter structures



ETT-101-40 Lab Manual - 15 comprehensive experiments



Lab 1: Special signals – characteristics and applications

Lab 2: Systems: Linear and non-linear

Lab 3: Unraveling convolution

Lab 4: Integration, convolution, correlation & matched filters

Lab 5: Exploring complex numbers and exponential functions

Lab 6: A Fourier series analysis

Lab 7: Spectrum analysis of various signals

Lab 8: Time domain synthesis of RC networks

Lab 9: Poles and zeros in Laplace domain

Lab 10: Sampling and Aliasing

Lab 11: Getting started with analog-to-digital conversion

Lab 12: Discrete-time structures: Finite Impulse Response (FIR) filters– FIR

Lab 13: Poles and zeros in the z-plane: IIR systems

Lab 14: Practical aspects of discrete time structures

Lab 15: Design & implement filters from specification

Lab 16: Exploring different digital filter structures, and comparing floating point and fixed point implementations

Students implement experiments by patching together functional blocks - such as samplers, independent adders, integrators, unit delays, etc.

The ETT-101-40 hardware, and lab manual experiments, can easily be integrated or adapted to suit your current signals and systems courses and text books.

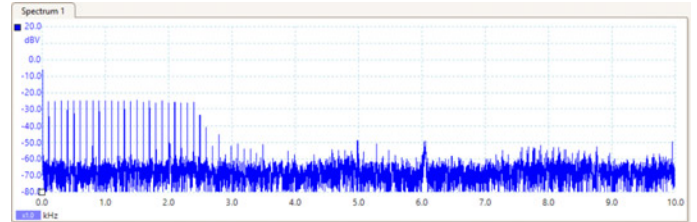
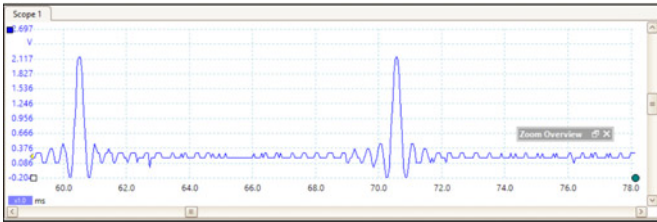

SIMPLE EXAMPLE

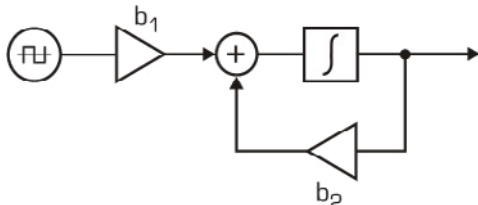

1 - Signals & Systems experiment block diagram

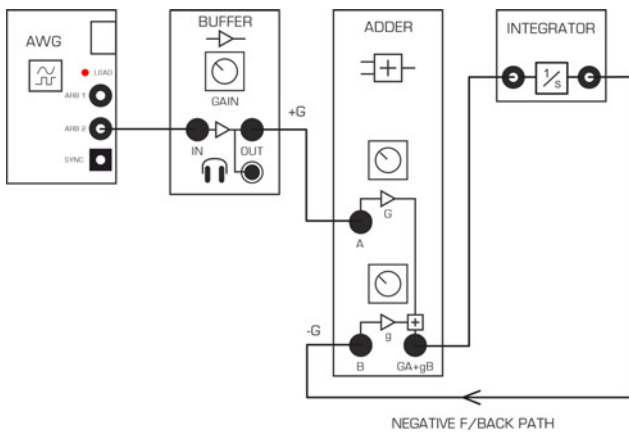

2 - Signals & Systems experiment patching diagram, as implemented on the hardware

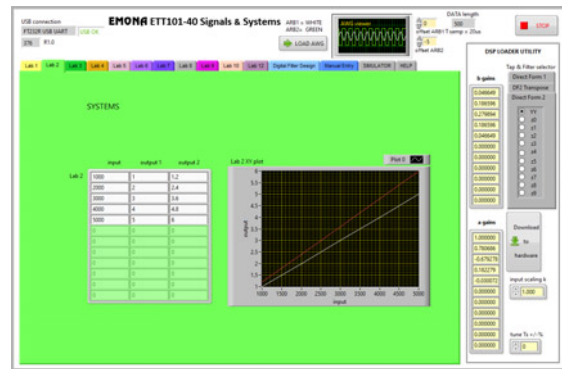

3 - Experiment hardware parameter control via the custom ETT-101-40 Soft Front Panel. One TAB is provided per experiment for ease of use by students

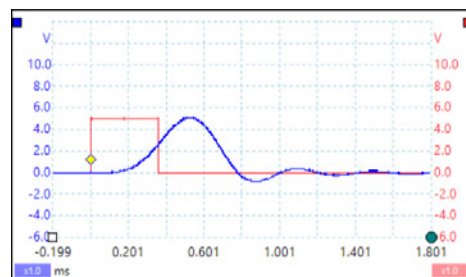

4 - Measure live, real-time signals and spectra



ETT-101/C Lab Manuals

7 Volumes of Fully Documented Student Experiments

MANUALS INCLUDED AS STANDARD WITH EACH ETT-101/C :

ETT-101 LAB MANUAL - Volume 1

(22 Chapters, 362 pages)

- Setting-up an Oscilloscope
- An Introduction to the ETT-101
- Modelling Equations
- Amplitude Modulation AM
- Double Sideband DSB Modulation
- AM Demodulation
- DSB Demodulation
- SSB Modulation & Demodulation
- FM Modulation
- FM Demodulation
- Sampling & Reconstruction
- PCM Encoding
- PCM Decoding
- BW Limiting & Restoring Signals
- ASK Modulation & Demodulation
- FSK Modulation & Demodulation
- BPSK Modulation & Demodulation
- QPSK Modulation & Demodulation
- Introduction to Spread Spectrum - DSSS modulation
- Undersampling in Software Defined Radio
- FM Demodulation - Discriminator Method
- QAM Modulation & Demodulation

ETT-101 LAB MANUAL - Volume 2

(23 Chapters, 476 pages)

- AM Method 2 & Product Detection
- Noise in AM Communications
- PCM and TDM
- Armstrong's Phase Modulator
- Phase Division Multiplex
- Pulse-Width Modulation & Demod.
- Message Translation & Inversion
- Carrier Acquisition using the PLL
- SNR and Eye Diagrams
- PCM and SNDR
- ASK Demod using Product Detect.
- FSK (switching method) & Demod.
- Principles of GFSK
- PN Spectra and Noise Generation
- Line Coding and Bit Clock Regen
- Delta Modulation & Demodulation
- Delta-Sigma Mod & Demod
- Observations of AM & DSBSC in the Frequency Domain
- Principles of superheterodyne
- Frequency synthesis with digital PLL

- Differential phase shift keying (DPSK)
- PAM-time division multiplexing (TDM)
- Pulse-Position Mod. & Demodulation

LAB MANUALS INCLUDED WITH ADD-ON BOARDS :

ETT-101 LAB MANUAL - Volume 3

(6 Chapters, 184 pages)

- Full (IQ branch) Demodulation of a QPSK Signal
- Line Code Decoding and Hard Decision Making
- DPSK Modulation and Demod with a Noisy Channel
- FM Demodulation using the Phase-Locked Loop
- Signal constellation Diagrams

NEW • Bit error rate measurements in a noisy baseband channels

Vol.3 experiments require the ETT-101-20, ETT-101-21, ETT-101-22 or ETT-101-23 boards

ETT-101 FIBER OPTICS LAB MANUAL - Volume 4

(11 Chapters, 280 pages)

- An Introduction to Fiber Optic Signal Transmission and Reception
- Guiding Light Using Total Internal Reflection *
- Losses in Fiber Optic Networks *
- Polarization *
- Bending Losses in Fiber Optic Systems *
- Connectors *
- PCM-TDM 'T1' Implementation
- Optical Signal Filtering, Splitting & Combining **
- Fiber Optic Bi-directional Communication **
- Wave Division Multiplexing (WDM) **
- Optical Losses **

* Experiments require the ETT-101-32 Physics of Fibers Accessory Kit.

** Experiments require the ETT-101-31 Coupler and Filters board.

NEW ETT-101 SDR Software Defined Radio USER & EXPERIMENT GUIDE

(150 pages)

- Familiarization with SDR software and hardware
- Run a loop-back demonstration
- Exploring sampling & resampling in SDR

- FM modulation in SDR, demodulation using ETT-101 hardware blocks
- SDR (IQ) mod. and demod., with ETT-101 hardware channel
- GMSK SDR (IQ) mod. and demod., with ETT-101 hardware channel
- FM reception using SDR
- Frequency Division Multiplexing (FDM) using SDR

LATEST ETT-101 SIGNALS & SYSTEMS LAB MANUAL - Volume 5

(16 Chapters, 330 pages)

- Special signals - characteristics & applications
- Systems: Linear and non-linear
- Unraveling convolution
- Integration, correlation & matched filters
- Exploring complex & exponential functions
- A fourier series analysis
- Spectrum analysis of various signals
- Time domain synthesis of an RC circuit
- Poles & zeros in the Laplace domain
- Sampling and aliasing
- Analog-digital conversion
- Discrete-time structures: Finite Impulse Response (FIR) filters
- Poles & zeros in the z plane with IIR systems
- Practical aspects of discrete time structures
- Design & implement filters from specification
- Exploring different digital filter structures, and comparing floating point and fixed point implementations

ETT-101-10 ELECTRONIC CIRCUITS PROJECTS MANUAL

(14 Projects, 50 pages total)

- RC Circuits • RL Circuits • RC & RL Low-Pass Filters • RC High -Pass Filters
- RC & RL Filters, Cut-off Frequency
- Measuring Filter Roll-off • Measuring Filter Phase Response • Series & Parallel RLC B-P Filters • RLC Band-Stop Filters • Effect of Components on Centre Freq. of Band-Pass & Band-Stop Filters • Effect of Component Values on Bandwidth of Band-Pass Filters
- The Hartley Oscillator • The Colpitts Oscillator • The Clapp Oscillator

Available from:

Emona Instruments Pty Ltd

78 Parramatta Road

Camperdown NSW 2050 AUSTRALIA

Tel: +61-2-9519-3933

URL: www.emona-tims.com

Email: sales@emona-tims.com

E&OE Specifications & details are subject to change without notice.

biskit™ is a trade mark of Emona TIMS Pty Ltd